

BEST 130 LIMITED EDITION

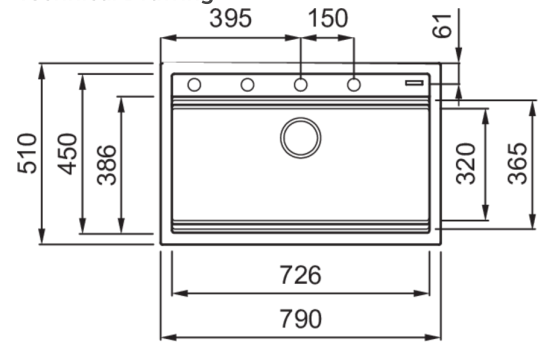

Technical Drawing



800

1-bowl sink

Model BEST 130 LIMITED EDITION

Base (mm) 800

Inset

Dimensioni (mm) 790 x 510

Dimensioni (mm)

Bowl Depth (mm) 200

Packaging Dimension (kg) 870 x 575 x 300

Packaging Cardboard and polyethylene

KERATEK^{plus}
CERAMIC NANOTECHNOLOGY CN6



LKB13086BKM K86
8032557029366

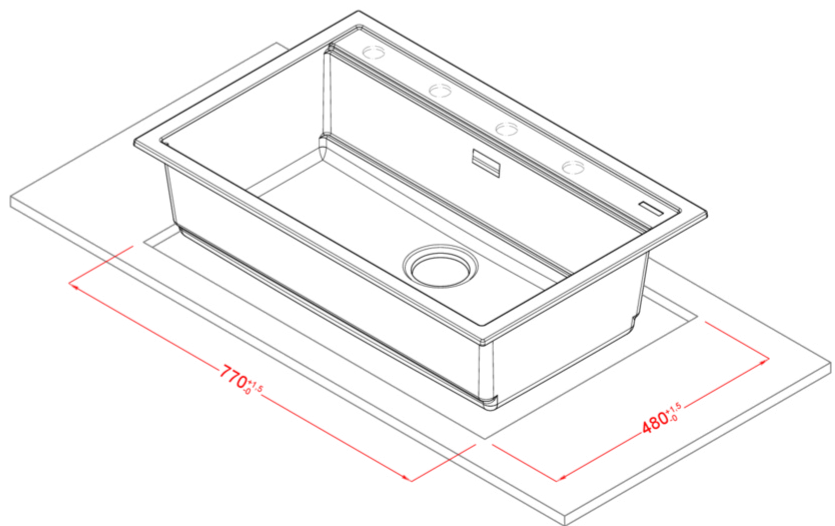
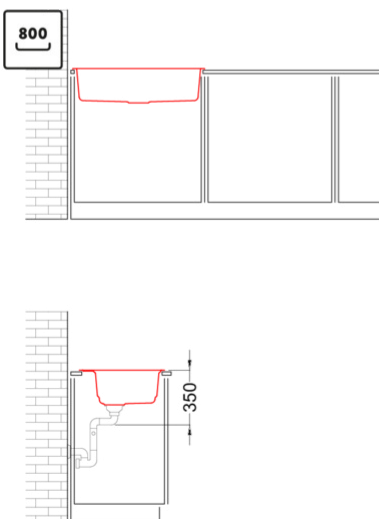
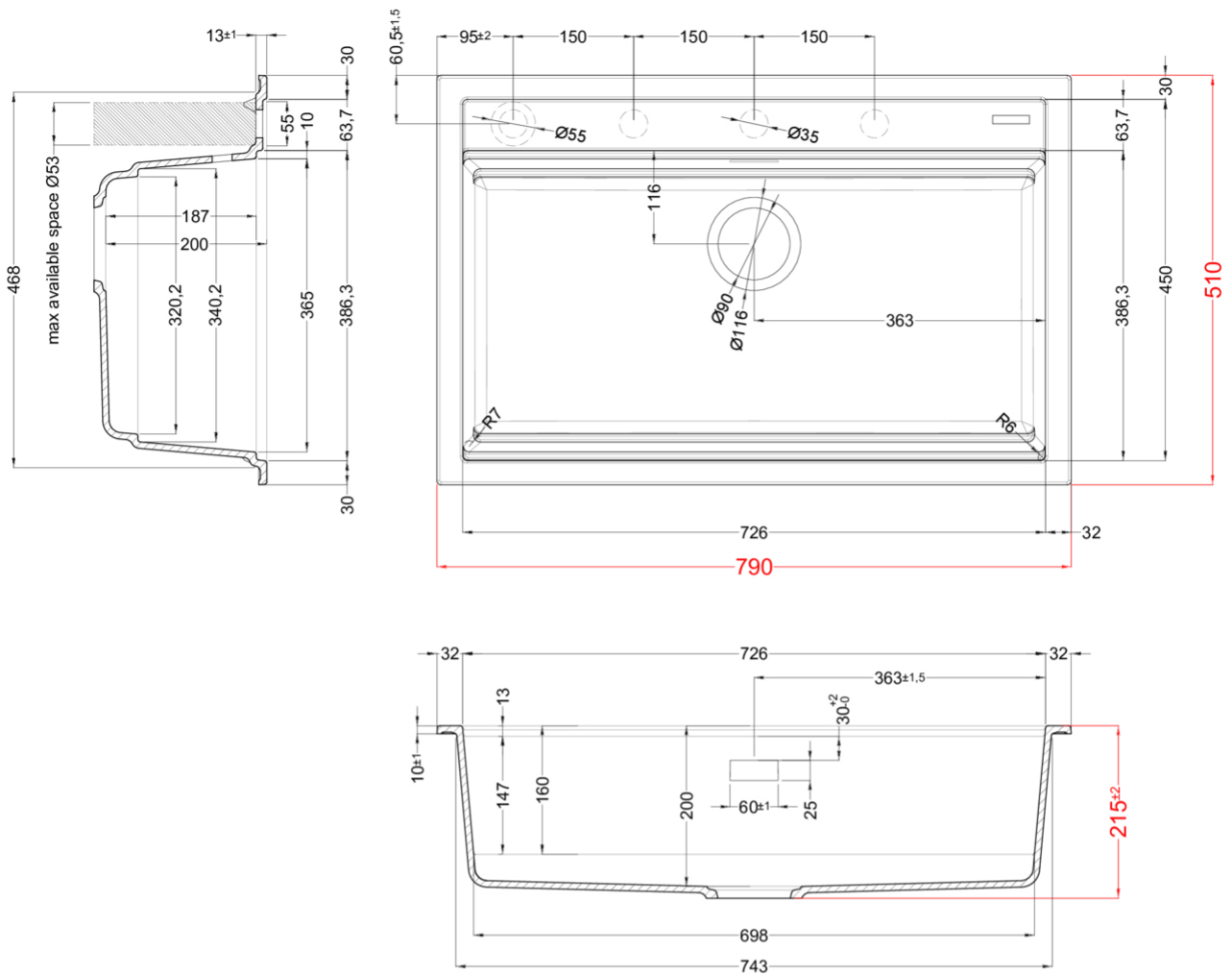

BEST 130

general tolerances where not expressly communicated $\pm 0.2\%$
 connection dimensions according to UNI EN 695

