

SINTESI 510

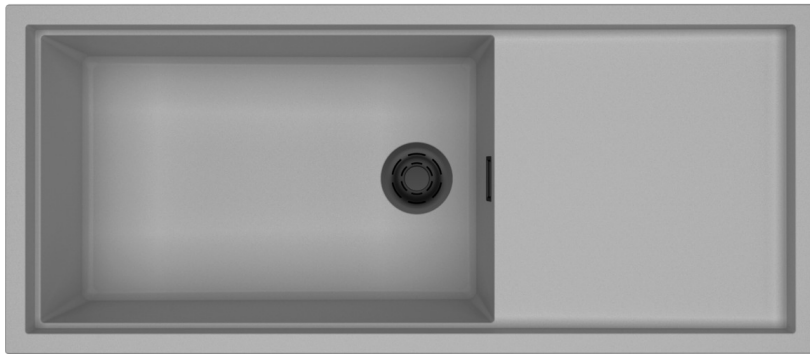

Technical Drawing

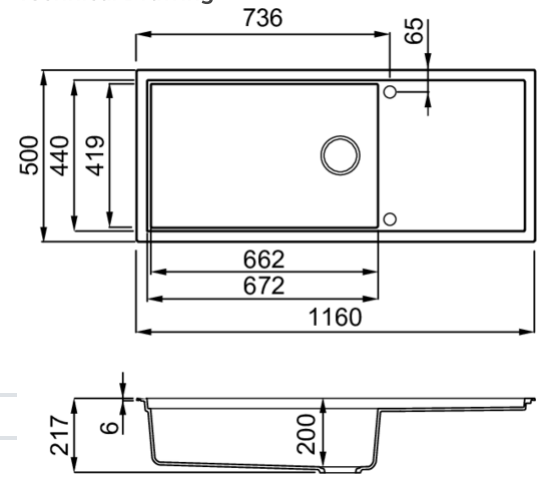

1-bowl sink with drainer *Available with coloured waste: Black Matt, Light Gold, Stainless Steel

Model	SINTESI 510
Base (mm)	If worktop height more than 35 mm base 800 If worktop height less than 35 mm base 1200 (Inset) - If worktop height more than 40 mm base 800 If worktop height less than 40 mm base 1200 (Flushmount)
Dimensioni (mm)	Inset Flushmount
Dimensioni (mm)	1160 x 500
Dimensioni (mm)	
Bowl Depth (mm)	200
Packaging Dimension (kg)	1250 x 575 x 300
Packaging	Cardboard and polyethylene

KERATEK[®] Plus
CERAMIC NANOTECHNOLOGY CN6



LKS51097BKM K97
8032557028406



LKS51096BKM K96
8032557028413



LKS51086BKM K86
8032557028420



LKS51083BKM K83
8032557028437



LKS51082BKM K82
8032557062981



LKS51097GLD K97
8032557028901



LKS51096GLD K96
8032557028918



LKS51086GLD K86
8032557028925



LKS51083GLD K83
8032557028932



LKS51082GLD K82
8032557063087



LKS51097 K97
8032557028659



LKS51096 K96
8032557028666



LKS51086 K86
8032557028673



LKS51083 K83
8032557028680



LKS51082 K82
8032557063032

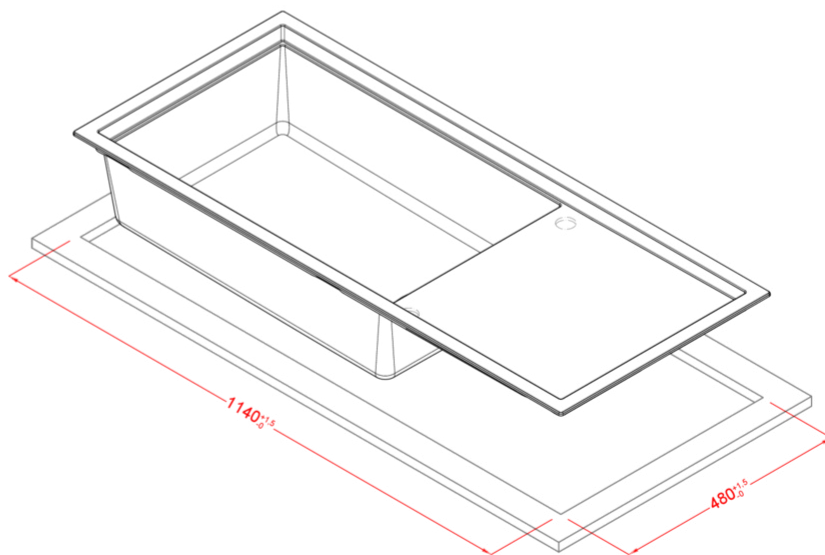
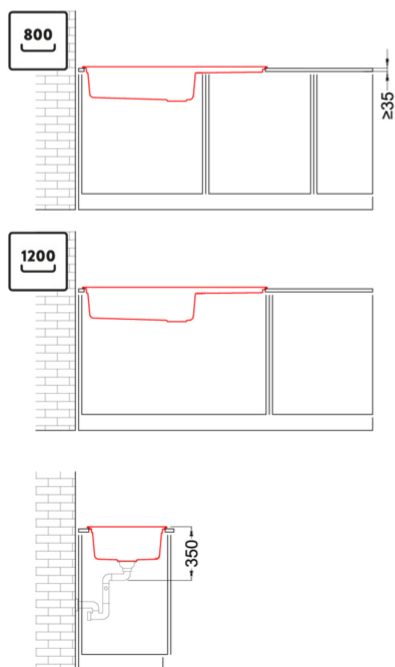
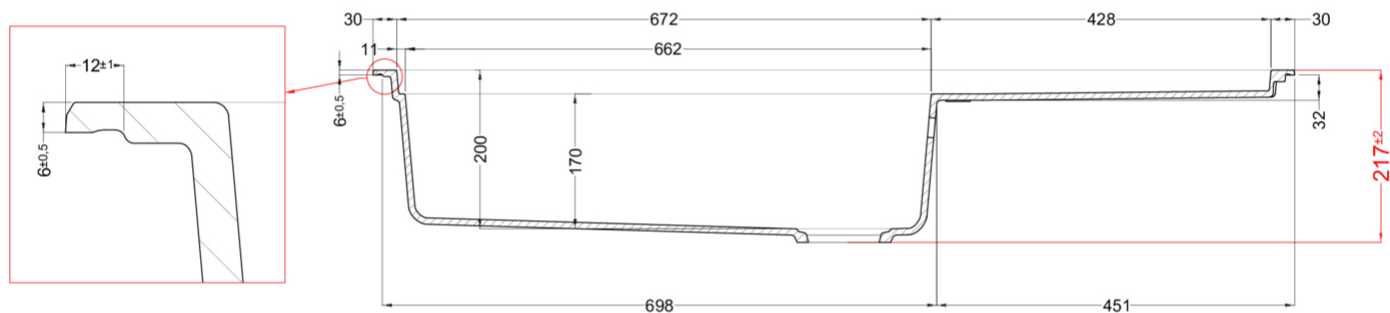
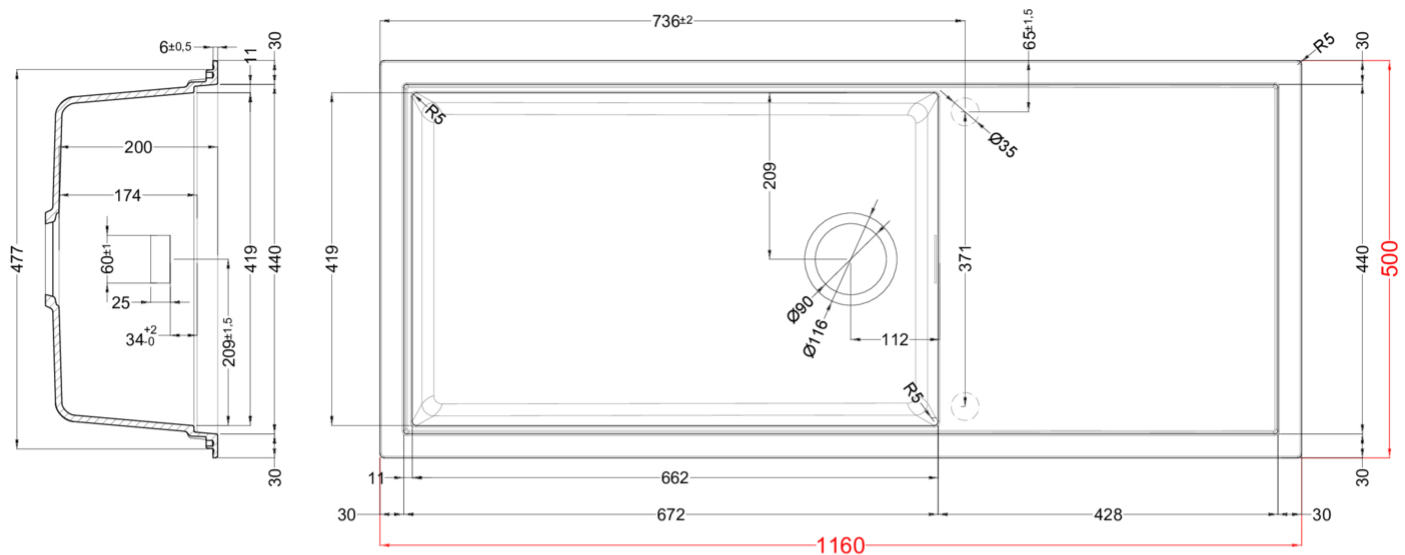

SINTESI 510

general tolerances where not expressly communicated $\pm 0.2\%$
connection dimensions according to UNI EN 695